



DIGITAL DISPLAY REFRIGERANT RECOVERY MACHINE

INSTRUCTION



ST-520D



DIRECTORY

Safety Instruction.....	01
Operational Attention.....	02
Application Skills.....	03
Technical Parameter.....	02
Recovery Unit Outside Drawing.....	06
Structural Decomposition Diagram.....	07
Display And Key Button.....	08
Function Instruction.....	10
Empty Recovery Cylinders.....	10
Retract Device Internal Piping Exhaust.....	11
Recovery Mode.....	12
Self-clean Mode.....	13
Push-pull mode.....	14
Troubleshooting And Maintenance.....	15

SAFETY INSTRUCTION

- * Use only the tank/cylinder passed the refillable safety certificate, the minimum pressure 45bar.
Don't recovery excess refrigerant gas in tank/cylinder, less than 80% of max capacity, retain space to prevent pressure increase cause explosion.
- * Wear safety goggles and protective gloves in operation, avoid refrigerant gas on skin and eyes, damage your health. (wash with water immediately and seek medical treatment if skin and eyes touch it.)
- * The device can't use in the place with Liquid overflow or combustible liquids container.
- * The tank/cylinder must adopt charging scale monitor when recovery refrigerant gas, avoid excess charge.
- * The place should be well-ventilated when operating device.

IMPORTANT TIPS

Please read and understand full content in the instruction, avoid to damage you or equipment.

Please check carefully the package box is in good condition and the accessories are complete.

Include Recovery unit, 1pcs filter, 2pcs Piston spare, 2pcs spare filters, operation manual, 1 year warranty. If inconsistent, please contact local distributor.

ATTENTION

WARNING

- * Product must be used by qualified expert or person who is familiar with air-conditioner and refrigeration system.
- * Ensure reliable and effective grounding when start device.
- * Electric cable must reliable and effective connect when using.
- * Only person with electrician certificates correct connect power based on Power Equipment technical Standard and wiring rules.
- * Cut off the power supplier and LCD screen no display before inspecting and maintaining device.

- * If the power line is damaged, please choose grounding line or buy from our company for replacement.
- * Consider current capacity of power supply, watt-hour meter, wire and socket before setting up an electric circuit.
- * The device is not suitable for A3 refrigerant gas. B2, B3 series toxic refrigerant.
- * Temperature range (0–50°C).
- * Make sure the fan mouth is free of debris.
- * Explosion and fire risk: Don't use in sewer attachments, poorly ventilated enclosed areas, near gasoline, acetylene or other flammable gas and flames or sparks. Don't pump hydrocarbons.

OPERATION ATTENTION

- * The power supply must be consistent with product identification.
- * Electric cable requirement:
 - 14AGW (Line diameter 1.63mm) or length not exceeding 50 feet (15m).
 - 12AGW (Line diameter 2.05mm) or length not exceeding 1000 feet (30m).Otherwise, the voltage may drop and damage the compressor.
- * Place the equipment horizontally while working. If put tilted, it may cause compressor vibration, increase the noise, even wear of parts.
- * Do not expose equipment to sunlight or rain.
- * Place the equipment in an open area and the vent can't be blocked.
- * Shut off by suitable charging hose with ball valve.
- * Monitor refrigerant gas weight by charging scale.
- * To avoid cylinder explosion, shut off cylinder when refrigerant gas capacity reach 80%.
- * Recovery refrigerant gas by certificated cylinder.
- * Recommended accessories.
- * To protect the device, please use filter of inlet port and regular cleaning, avoid the contaminated refrigerants enter.
- * Monitor pressure and temperature.
- * The equipment hasn't residual refrigerant gas after using self-clean ST-520D, avoid different refrigerant gas mix in the same recycled cylinder.

APPLICATION SKILLS

Understand the refrigerant system and match your recycled cylinder.

- * Charging hose: short hose is better (3/8 charging hose, 1/4 charging hose), remove valve core.
 - Shut-off valve is vulnerable parts, replace it after vulnerable.
- * Recovery will be more convenient and fast if with manifold gauges.
- * Use valve core wrench remove valve core from valve.
- * Push-pull mode can be used when recovery massive refrigerant gas.
- * Recycled cylinder should exhaust to 29.6"Hg (-75cmHg) before using.
- * You should know how much refrigerant gas need recovered before start.
- * Ensure recycled cylinder has enough space, recovery gas can't exceed 80% of cylinder capacity, monitor and prepare another cylinder.
- * The charging hose hasn't gas residue, decrease cylinder temperature and pressure by water when the cylinder is overheated.
- * If the cylinder pressure is higher than expected, empty recycled cylinder and move compressed refrigerant gas to other cylinder. (page 10)
- * Try to recovery more liquid refrigerants before gaseous refrigerants recovery.
- * The colder cylinder, the faster recovery.
- * The heat gun can heat refrigerant pipe, make refrigerant gas heat.
- * Both gaseous and liquid tubes recovery at the same time, faster gas recovery.
- * Adjust the recycling position to the dotted line when recovery speed is too fast cause the liquid gas condensation block the piston.

Thanks for purchasing  products. For safe and correct using, please read this user instruction carefully before using the product.

PRODUCT DESCRIPTION

ST-520D is intelligent recovery unit with brushless motor, digital pressure gauge and digital Integration module. Recovery speed fast, motor power strong, sparkless and safe, small size and light weight reliable, convenient carry. Recovery III (134A), IV (R407C), V (R32, R410A) series refrigerants.

Thank you very much for your purchase  premium refrigeration tool series.

PRODUCT CHARACTERISTICS

- * HD LCD screen;
- * Brushless motor (High power 1 HP);
- * One button operation;
- * Small size, weight light (10kg), convenient carry;
- * Sparkless design, use for refrigerant gas R32、R600、R134A、R410A etc.

TECHNICAL PARAMETER

ST-520D	
Suitable refrigerant gas	III series: R12, R134a, R401C, R406A, R500, 1234YF IV series: R22, R401A/B, R402B, R407C/D, R408A, R409A, R411A/B, R412A, R502, R509 V series: R402A, R404A, R407A/B, R410A, R507, R32
Cylinder quantity	2 cylinder
Power supply	220V-240V, 50/60Hz
Motor	750W(1HP)
Speed of revolution	2500 RPM
Electric current	220V:6A
Compressor	No oil lubricate, Forced air cooling, Piston type
High pressure protection	38.5bar / 3850kPa(558psi)
operating temperature	0°C ~ 40°C / 32 ~ 104°FHz
Dimensions	375 × 250 × 320 mm
Net weight	10 kg

Refrigerant gas	R134a	R22	R410A
Liquid	2.40 kg/min	2.70 kg/min	3.50 kg/min
Push-pull mode	7.50 kg/min	8.50 kg/min	9.50 kg/min

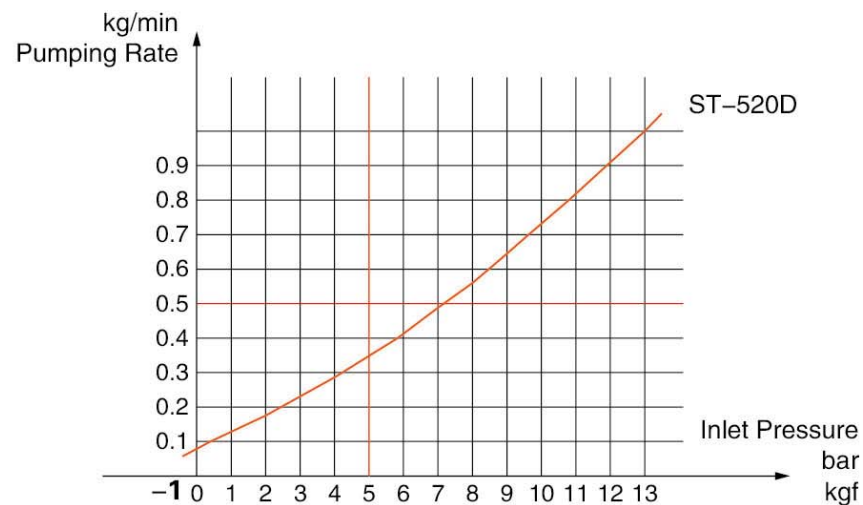

 Note: The gas pumping rate is proportional to the inlet pressure.

Thanks for purchasing  products. For safe and correct using, please read this user instruction carefully before using the product.

RECOVERY UNIT OUTSIDE DRAWING



STRUCTURAL DECOMPOSITION DIAGRAM

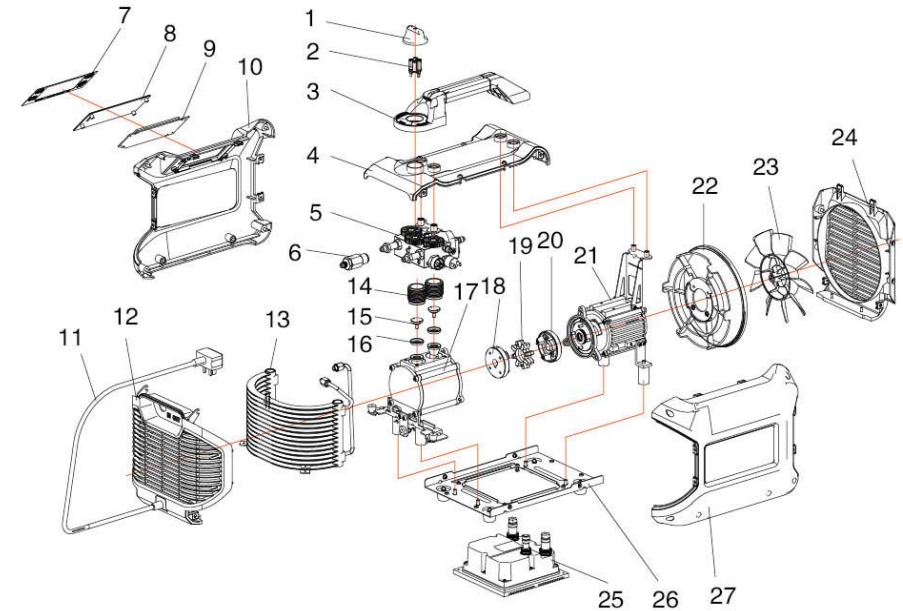

S/N	Accessories name
1	Control knob
2	Knob connecting socket
3	Handle
4	Cover
5	Valve control panel
6	Filter
7	Display screen Key Label
8	Display screen transparent panel
9	Display screen circuit board
10	Front shell
11	Power line
12	Right shell(Condenser)
13	Condenser
14	Cylinder

S/N	Accessories name
15	M6 screw tightener
16	Piston
17	Box set
18	Coupling aluminum sleeve
19	Plum Blossom Mitigation Pad
20	coupling aluminum sleeve
21	Motor set
22	Fan cover
23	Fan
24	Left shell(Fan)
25	Motor Control set
26	Baseplate
27	Back shell

Thanks for purchasing  products. For safe and correct using, please read this user instruction carefully before using the product.

DISPLAY AND BUTTON

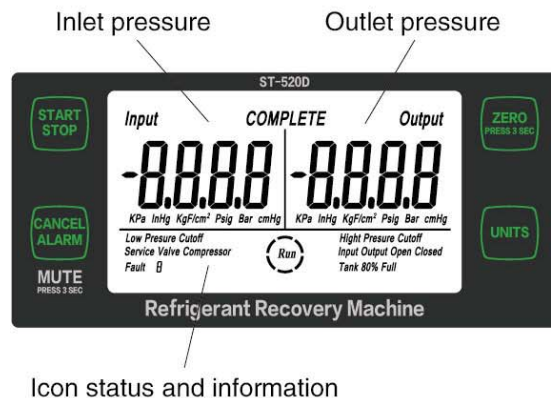

START/STOP: Start/Stop Motor

ZERO [Long press 3 seconds]: Zero pressure sensor, ports must connect with atmosphere

CANCEL ALARM: Cancel alarm [Temporarily mute]

MUTE [Long press 3 seconds]: All sounds mute [Settings saved]

UNITS: Choose pressure / Vacuum unit

ICON STATUS AND INFORMATION

 When the motor is running, the icon turns

Low Pressure Cutoff: Motor shutdown, inlet port vacuum degree low

Fault 1: Hardware overcurrent protection

Fault 2: Software overcurrent protection

Fault 3: Overvoltage protection

Fault 4: Undervoltage protection

Fault 5: High temperature protection

Fault 8: Other protection

PORT LINE CONTROL



CLOSE POSITION

- * Close inlet and outlet;
- * Set close position, close 2 ports during setup;



SELF-CLEAN POSITION

- * Close inlet and open outlet;
- * Finish recovery, set to close inlet port before clearing;



RECOVER POSITION

- * Open Inlet and outlet port;
- * Set to open inlet and outlet port during massive recover process;



RECOVER POSITION (REDUCE EXPENDITURE)

- * Open part inlet and outlet port;
- * If the liquid gas condensation block the piston, please counterclockwise rotation from recover position, reduce liquid impact. Decrease the refrigerants flow rate and make the machine run smoothly;
- * Reduce expenditure as requirement to achieve smooth operation;

Thanks for purchasing  products. For safe and correct using, please read this user instruction carefully before using the product.

REFRIGERANT FLOW

Refrigerant liquids and gases are pushed into machine due to the compressor pressure difference. In order to achieve maximum performance, increase the inlet pressure and reduce the outlet pressure.

See Application Tips (page 9)

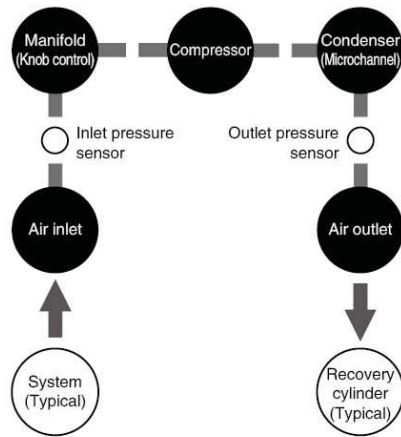

DYNAMIC PRESSURE MEASUREMENT

The ST-520D pressure reading is designed to monitor pressure only. Do not use the ST-520D for dynamic pressure measurements.

If the system pressure is stable, the ST-520D pressure reading will be close to your other gauges. If the system pressure changes, the pressure measurement will be different at different points in the system. For each 1 meter 1/4" refueling tube, the pressure difference is approximately ± 20 psig.

FUNCTION INSTRUCTION

EMPTY RECOVERY CYLINDERS

* When the cylinder pressure is higher than expected, a non-condensing refrigerant will be appeared at the top of the cylinder. Use additional deeply vacuumed cylinders to extract the non-condensing refrigerant.

1. Pressurized cylinders must not be disturbed at night.
2. Vacuum another cylinder.
3. Connect the closed gas ports of the two cylinders with a manifold.
4. Measure the gas temperature of pressurized refrigerant cylinder.
5. Use a pressure/temperature meter or a digital meter set to find the rated pressure.
6. Open exhaust port.
7. Open (empty) the pressurized air port until the pressure is reduced to 5 psi above the rated pressure.
8. Close valve.
9. Repeat within 15 minutes, if required, to resettle the refrigerant in the cylinder.

RETRACT DEVICE INTERNAL PIPING EXHAUST

READY FOR OPERATION

* Connect hoses as shown below, make sure they are connected correctly and securely.

1. Open manifold gas and liquid valves.
2. Close gas and liquid valves for refrigerant recovery cylinders.
3. Loosen the ball valve hose connecting the recovery cylinder gas valve.
4. Open the globe valve on the ball valve hose.

START RUNNING

5. Plug in the power and the LCD screen will display the intake and exhaust pressure.
6. Turn the knob to the "recovery" position.
7. Press "START" to START the device and START to clear the air inside the pipe.
8. Observe the indication value of low pressure. When the indication value drops to -20 inhg, the device stops 20 seconds later.
9. Turn the knob to the "off" bit and press the "START" button to START the device.
10. Slowly turn the knob to the "self-cleaning" position and start self-cleaning.
11. Observe the indication value of low pressure. When the indication value drops to -20 inhg again, the device stops 20 seconds later.

END OF RUN

12. Turn the knob to the "close" position, and the end is self-cleaning.
13. Connect the ball valve hose to the recovered cylinder.

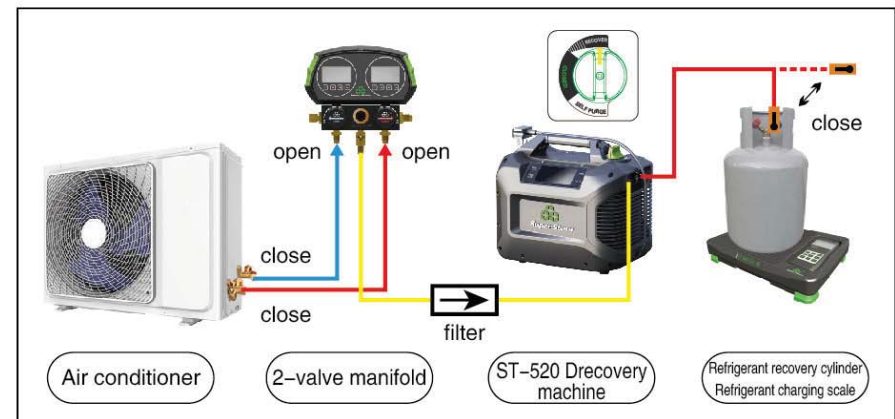

Thanks for purchasing  products. For safe and correct using, please read this user instruction carefully before using the product.

RECOVERY MODE

READY FOR OPERATION

* Connect hoses as shown below, make sure they are connected correctly and securely.

* Make sure all valves are closed before connecting.

1. Power off the refrigeration unit.
2. Open the gas valve and the liquid valve of the refrigeration unit.
3. Open the gas valve of refrigerant recovery cylinder.

START RUNNING

4. Turn the knob to the "recovery" position.
5. Press the "START" button to START the device.
6. When the gas is recovered, open the gas valve of the manifold; When the liquid is recovered, open the liquid valve of the manifold.
7. The recovery can be ended by running to the desired vacuum or low-voltage protection automatic shutdown state.

*** After the recovery, the power is not turned off and the self-cleaning mode is directly operated.**

⚠ ATTENTION

1. If there is a liquid slugging on the compressor at the "recovery" position, turn the knob slowly counterclockwise. At this point, the indicator value of the low-pressure meter drops until the slugging stops. However, do not reduce

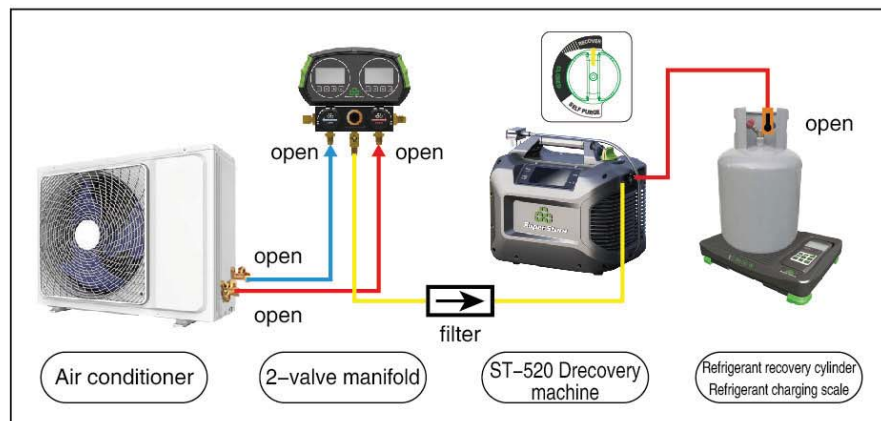

the pressure value to 0.

2. If it is difficult to START again after power off, turn the knob to the "close" position and press the "START" button to START the device, then turn the knob to the "recovery".
3. This operation must be monitored by an electronic charging scale.

SELF-CLEAN MODE

⚠ ATTENTION

* The equipment must be self-cleaning after each use.

* The residual liquid refrigerant may expand in the condenser and cause damage to the components, which is harmful to the environment.

START RUNNING

1. Automatic shutdown after recovery.
2. Turn the knob to the "close" position and press the power button to start the device.
3. Slowly turn the knob to the "self-cleaning" position and start self-cleaning.
4. Run to the required vacuum, self-cleaning stop automatically.

END OF RUN

5. Turn the knob to "close".
6. Close the stop valve of the outlet .
7. Close the gas valve of refrigerant recovery cylinder; Close the gas valve of refrigerant recovery cylinder.

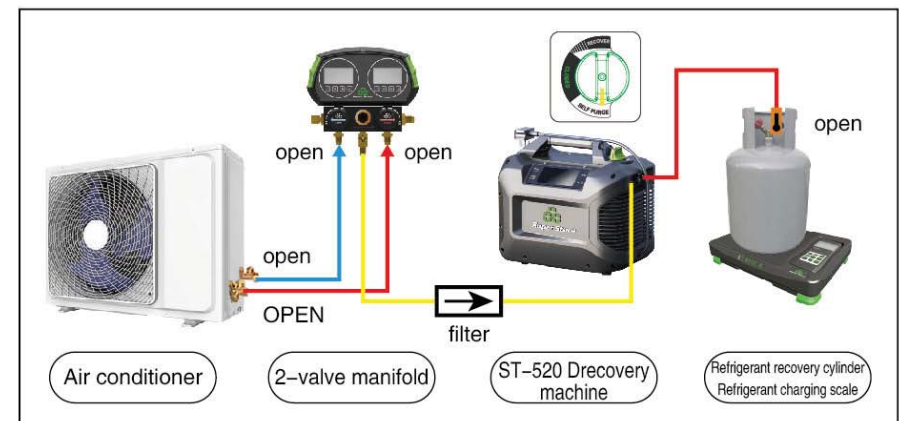

Thanks for purchasing  products. For safe and correct using, please read this user instruction carefully before using the product.

PUSH-PULL MODE

⚠ ATTENTION

* This operation process must use an electronic charging scale to monitor the amount of recovery

READY FOR OPERATION

- * Connect hoses to ensure correct and firm connection; (refer to the following connection diagram).
- * Ensure that the refrigeration unit, refrigerant recovery equipment (st-520d), refrigerant recovery cylinder gas valve, liquid valve are closed.

START RUNNING

1. Open the gas valve and the liquid valve of the refrigeration unit.
2. Open the gas valve and liquid valve of refrigerant recovery cylinder.
3. Turn the knob to the "recovery" position.
4. Press the "START" button to START the device and START the push-pull mode.
 - * When the value displayed by the electronic scale remains unchanged or changes slowly, it means that the liquid inside the refrigeration unit has been recovered and can be recovered as a gas.
5. Slowly turn the knob to the "self-cleaning" position and recover the liquid in the self-cleaning mode.
6. Turn the knob to "close".
7. Close the gas valve and liquid valve of refrigeration device.



8. Close the gas valve and liquid valve of refrigerant recovery cylinder.
9. Reconnect the hose and recycle the refrigerating unit in a gaseous manner according to the recovery mode.

END OF RUN

TROUBLESHOOTING

STATUS INFORMATION

1. Fault=1

Motor current is too high. It may be caused by the following reasons: the equipment temperature is too high, the liquid recovery time is too long, the cylinder pressure is too high. The motor can recover after cooling.

If this failure continues to occur multiple times after recovery, the device may be out of order.

2. Fault=2

The software detects that the device current is too high, the reason is the same as above (Fault=1).

3. Fault=3

Power Grid voltage is too high. The possible cause is that the voltage of the power grid is too high or unstable. Please check whether the power grid voltage exceeds 250V or there is a large fluctuation.

4. Fault=4

Power Grid voltage is too low. The possible cause is that the voltage of the grid is too low or unstable. Please check whether the voltage of the grid is lower than 180V or there is a large fluctuation.

5. Fault=5

Equipment temperature is too high. The cause is that the current temperature of the equipment is too high, which can be recovered after cooling.

6. Fault=8

Other unknown faults. If it happens multiple times, it could be a device failure.

Thanks for purchasing  products. For safe and correct using, please read this user instruction carefully before using the product.

OTHER FAULT

Problem	Reason	Solution
Switch on the power, the display does not respond	<ol style="list-style-type: none"> 1. The internal connection is loose 2. Circuit board fault 	<ol style="list-style-type: none"> 1. Check the connection wire for firmness 2. Replace the circuit board and send it back to the factory for repair
Press the start button, the machine has no response	<p>The display doesn't work</p> <ol style="list-style-type: none"> 1. Power cord or socket failure 2. Circuit board fault <p>Display light on</p> <ol style="list-style-type: none"> 1. External pressure is too high 2. Damage of motor or other parts 	<ol style="list-style-type: none"> 1. Check whether the power cord and socket are in good condition 2. Replace the circuit board and send it to the factory for maintenance. <ol style="list-style-type: none"> 1. Turn the knob to "position" and restart. 2. Replace components and send to factory for maintenance.
The machine stops after a period of operation	<ol style="list-style-type: none"> 1. Improper operation causes the high pressure switch to disconnect, such as the ball valve switch not opened and the valve on the recovered cylinder. 2. The recovery is over and the device is under low pressure protection. 	<ol style="list-style-type: none"> 1. Please read the instructions carefully and follow them strictly. 2. See the recovery self-cleaning operation steps for self-cleaning operation.
Recovery is too slow	<ol style="list-style-type: none"> 1. The pressure of the recovered cylinder is too high 2. Compressor piston ring damaged 	<ol style="list-style-type: none"> 1. Cooling the recovered cylinder lowers the temperature, causing the pressure to drop 2. Return to factory for repair
The equipment can't be vacuumed	<ol style="list-style-type: none"> 1. Loose pipe connection 2. Equipment leakage 	<ol style="list-style-type: none"> 1. Tighten the pipe connection 2. Return to factory for repair

MAINTENANCE

GENERAL CONDITION

- * Wipe the outside with a damp cloth and do not use solvents.
- * To extend the service life of the internal seal, occasionally inhale a teaspoon of mineral oil through the ST-520D pump.

FILTER CLEANING

- * When the filter becomes dirty and clogged, it will affect ST-520D recovery efficiency. Clean or replace the filter frequently
1. Unscrew the (counterclockwise) connection.
 2. Clean or replace the filter.
 3. Manually tighten (clockwise) the connection.

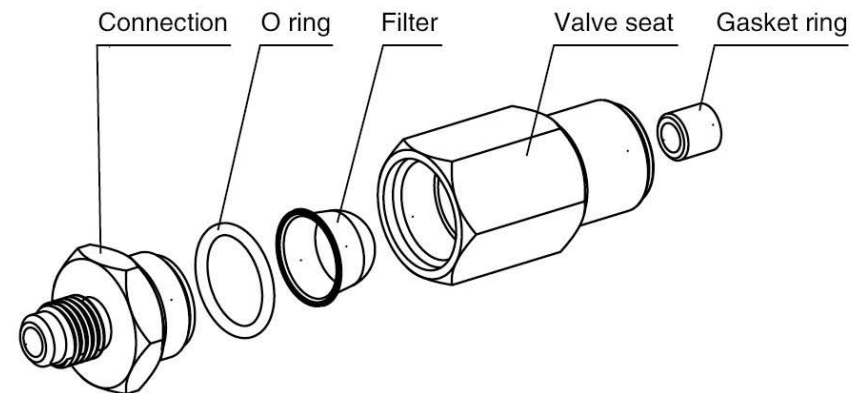

Filter diagram